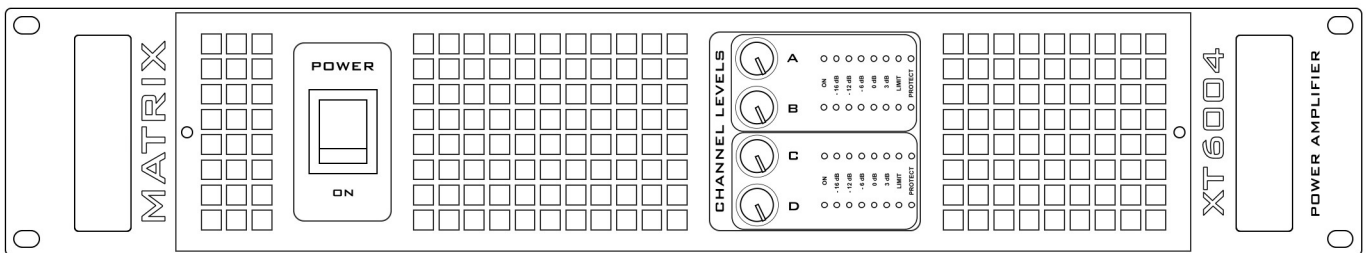

MATRIX

AMPLIFICATION

XT SERIES

AMPLIFIER

USER MANUAL



MODELS COVERED:

XT2004

XT4004

XT6004



DESIGNED AND MANUFACTURED
IN THE UK BY MATRIX.



MATRIX AMPLIFICATION

Thank You

Congratulations on the purchase of your new Matrix Professional Power Amplifier. Matrix amplifiers are the result of many decades of experience in the design of exceptionally robust and reliable amplifiers. They are designed to breathe life into your sound, by controlling your speakers with exacting authority through the uncompromising delivery of clean, undistorted power, from a package which is smaller and lighter than you might expect for the performance it delivers.

This manual will help you to get the most from your amplifier. For maximum benefit, it is recommended that all instructions and warnings are carefully read. Also be sure to read the notices regarding correct wiring of output connectors as this impacts the operation of the amplifier.

For warranty service, please retain your receipt and all packaging that comes with the amplifier, as it has been specifically designed to transport the amplifier safely.

Unpacking

Please unpack and inspect your new amplifier for any damage that may have occurred during transit. If damage is found, notify the carrier immediately.

Note: A suitable mains lead is provided and can be found packaged with the amplifier.

PLEASE RETAIN ALL FACTORY PACKAGING FOR ANY FUTURE POSTAL TRANSIT.

CONTENTS:

	Page
Thank You	1
1. Features and Innovations	2
2. Specifications	3-4
2.1 Technical specifications	
2.2 Basic Schematics	
3. Interface Elements	5-7
3.1 Front Panel	
3.2 Rear Panel	
4. Recommended Usage	8
5. Cables, Making your own	9-11
6. Trouble Shooting	12
7. Warranty	13
8. Declaration of CE Conformity	14

CAUTION:



OBSERVE ALL SAFETY AND USAGE INSTRUCTIONS TO AVOID POSSIBLE DAMAGE TO EQUIPMENT AND EXPOSURE TO HAZARDS (THIS SYMBOL UNIVERSALLY FLAGS CAUTION NOTICES)

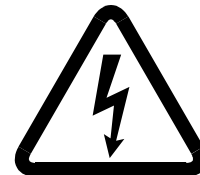

LETHAL VOLTAGES PRESENT AT SPEAKER TERMINALS AND INSIDE THE AMPLIFIER; ENSURE ALL WIRING IS SAFE AND CORRECT BEFORE USE. (THIS SYMBOL ALSO UNIVERSALLY FLAGS ELECTRICAL HAZARDS)

DO NOT OPEN THE AMPLIFIER; LEAVE ALL INTERNAL SERVICE OPERATIONS TO A QUALIFIED TECHNICIAN.

1. Features and Innovations

All our amplifiers have been designed to give the best possible performance for their intended application and are based on our own uncompromising, time proven MOSFET designs. These take advantage of components which will stand the test of time and give the best possible performance in a small, exceptionally light weight package.

We only have the desire to provide our users with the best possible solutions and continue to look for ways to improve upon them.

Amplifier features:

- **Class AB, MOSFET amplifier topology.**
- **An unprecedentedly powerful and stable Switch Mode Power Supply.**
Designed without compromise, to exceed the performance of the previous linear supply models; whilst offering a weight advantage rarely seen even in other SMPS amplifiers.
- **Soft Start Circuit.**
The power supply is designed not to draw excessive current on startup - Prevents the 'thump' as occasionally occurs with other equipment, from tripping fuses and breakers.
- **Protection against Short Circuit and Overheating.**
- **Speaker Protection relay with delay to inhibit switch on thump.**
The speakers are disconnected during power up/down.
- **Fully balanced XLR Inputs.**
- **Temperature regulated, High Speed Fan Cooling.**
A new high speed fan is utilised to ensure maximum reliability by allowing for far greater cooling latitude (The amplifier vents hot air through rear connector panel).
- **4 Channel Model.**
4 channels of amplification provided in a case size which would normally only offer 2 channels; Optimising the use of available racking space in complex amplifier installations.

2.1 Technical Specifications

	XT 2004	XT 4004	XT 6004
Number of Channels:	4	4	4
Watts Per Channel at - 8 Ω:	300	650	900
Watts Per Channel at - 4 Ω:	500	1000	1200
Watts Per Channel at - 2 Ω:	-	-	-
	-	-	-
	-	-	-
Supply Voltage:	230V +/- 15%	230V +/- 15%	230V +/- 15%
Average Supply Current, Full Load:	5A	10A	16A
Mains Connector:	20A Powercon	20A Powercon	20A Powercon
Frequency Response:	8–24,000 Hz	8–24,000 Hz	8–24,000 Hz
Signal to Noise Ratio (ref. Full power 1kHz):	99 dB	101 dB	102 dB
THD (1kHz, full power):	0.07%	0.07%	0.07%
THD (20Hz - 20kHz, full power):	<0.1%	<0.1%	<0.1%
Slew Rate:	65 V/ μ s	69 V/ μ s	69 V/ μ s
Damping Factor (ref. 8R, 100Hz):	>400	>550	>650
Cooling Fan Arrangement: (Temperature controlled dual speed fans)	2x 80mm	2x 80mm	2x 80mm
Cooling Airflow Direction:	Front to Back	Front to Back	Front to Back
Dimensions (mm):	482 X 88 X 370	482 X 88 X 370	482 X 88 X 370
Weight:	8.2 Kg	8.5 Kg	8.7 Kg
Additional Features:	-	-	-

Operating Environment:

- The amplifier is designed for use in environments which protect it from rain, unusually high air humidity and temperature.
- When mounting inside, ensure that the amplifier is securely bolted into a rack using all available fixing points where possible. Otherwise place on a surface where it cannot be easily displaced, Potentially causing damage/injury. Ensure That the location will not expose the amplifier to spillage of liquids/drinks, sprays/vapours or high humidity. Ensure the amplifier is installed in a place which is not subject to abnormally high temperatures and maintain sufficient ventilation to prevent overheating.
- For temporary use outside, apply similar caution; however be extra sure to ensure placement accounts for changing weather conditions and that extreme wind/rain/heat will not find its way to equipment.
- When taking any equipment from a cold environment (unheated storage, vehicles, etc), into a warm one, allow the equipment time to acclimatise to the ambient temperature, as condensation is likely to form in the amplifier, potentially causing it to malfunction if put into service too soon.

Note: Our policy of continuous improvement may lead to the above specifications being exceeded prior to documentation being updated.

2.2 Basic Schematics.

Note: The Diagrams shown here for channels A and B, also apply for channels C and D.

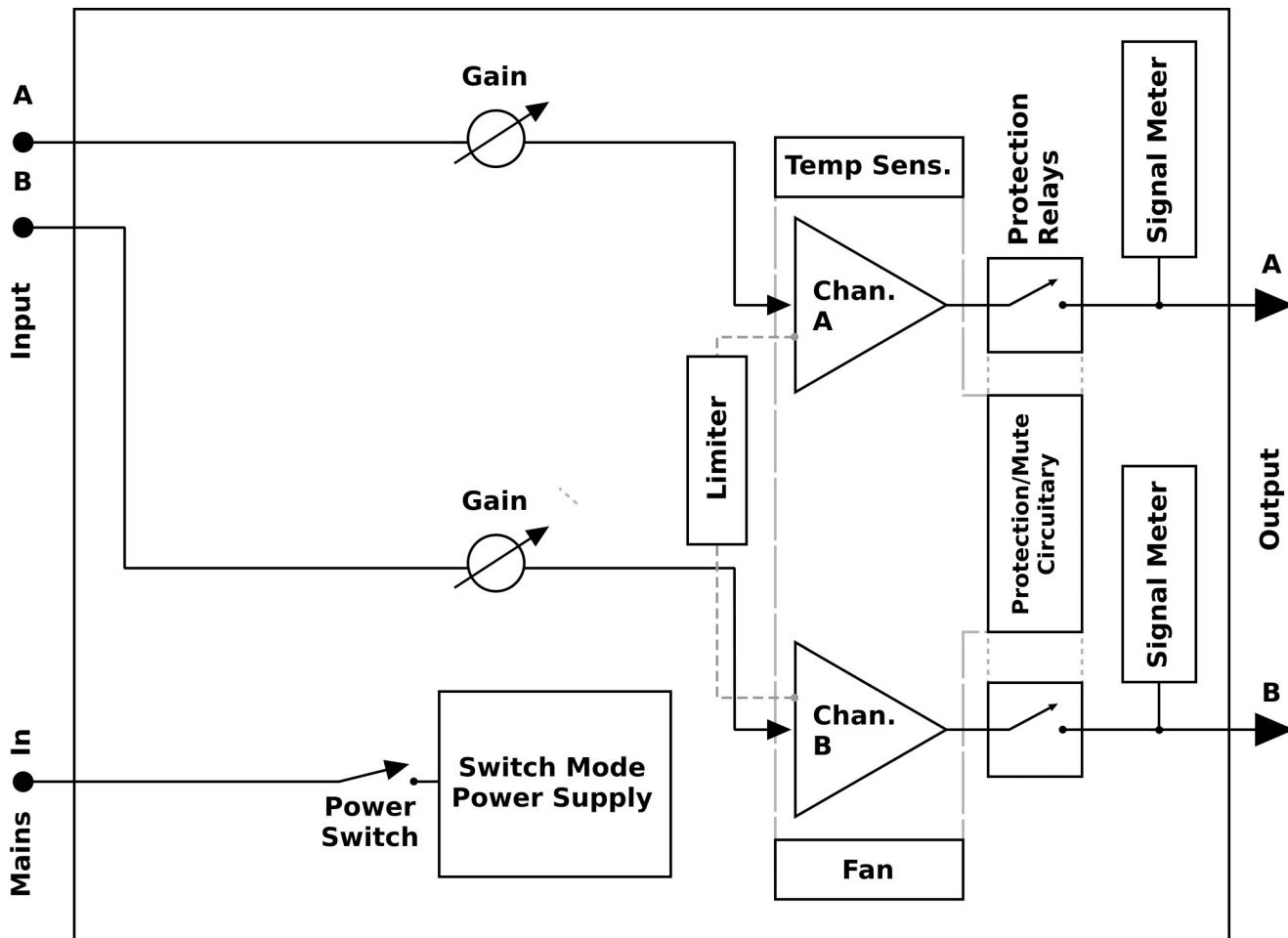

Output Connections:

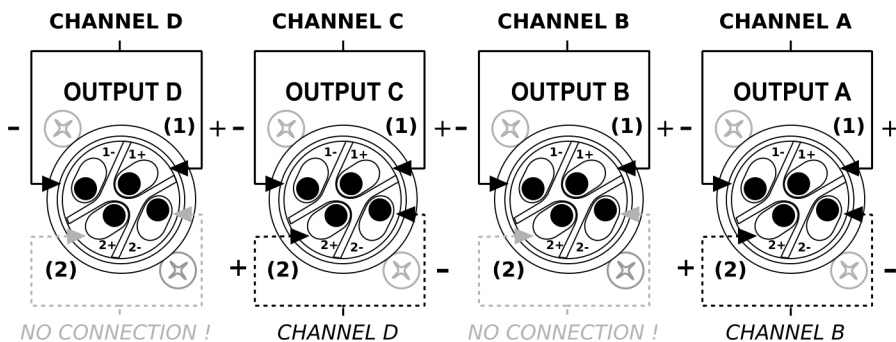

3. Interface Elements, Front Panel.

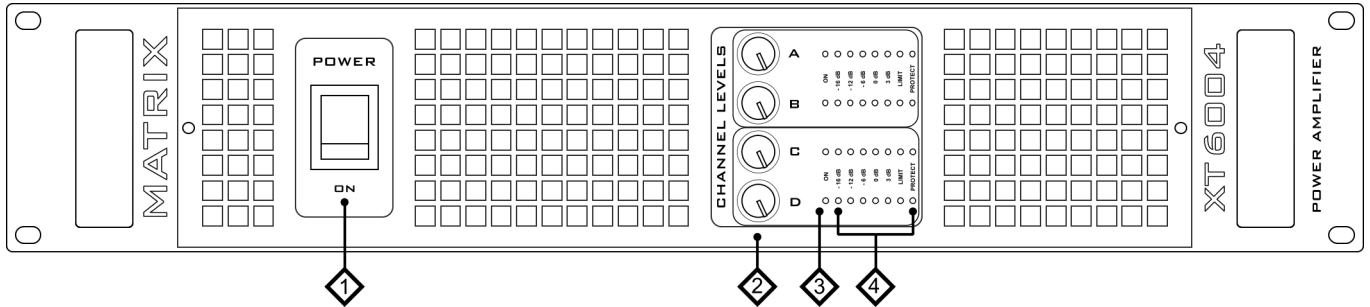

(1) Power Switch

This switch controls the power supply to the amplifier. There is a short delay on power-up, this is to avoid switch-on "thump" which could damage the loudspeakers.

(2) Gain Controls

The level of each Channel is individually adjusted by these controls. Rotating these controls fully clockwise, results in no attenuation to the incoming audio signals.

(3) Indicator Section, Status:

a. Power Indicators

This indicator shows when the amplifier is on and each channel is receiving power.

(4) Indicator Section, Signal levels:

a. Output Level Display

These show the (Peak) output level of the amplifier for each channel, in both Stereo and Mono modes. It is useful to note for trouble shooting, that the sensors for the Output Level Display, detects levels after the output relays. Therefore if the display is operating, a signal is present at the speaker sockets.

b. Limit Level Indicators

These illuminate to show that the amplifiers limiting circuitry is active. Repeated illumination indicates that the amplifier is being driven excessively and a reduction in level is recommended.



c. Protect Indicators

These indicators light briefly during the power up cycle and also light should a fault occur. Illumination of the protect indicators, shows that the output of the amplifier has been disconnected by means of an internal relay to protect connected speaker systems from being damaged by the fault.



3. Interface Elements, Rear Panel.

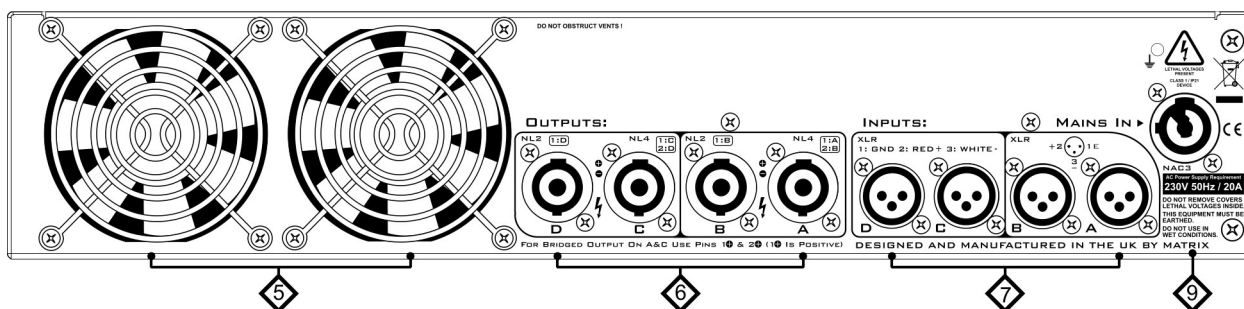

(5) Cooling Fan Outlet

Hot air exits here. Make sure all rear (and front) ventilation paths are free from obstruction and air flows freely, otherwise the amplifier will trip into thermal protect mode prematurely and in some extreme circumstances damage may occur.



(6) Output Connectors

The Output sockets are Neutrik Speakons and accept a Neutrik NL4FC plug. Avoid inferior alternatives, as they may present numerous hazards due to less than ideal construction.

Insert the plug and turn clockwise until you hear it click. This ensures correct connection has been made. To remove, pull back the levered tab and turn anti-clockwise.

Ready-made, sensibly priced, quality interconnection leads suitable for use with the amplifier should be easy to source. However, with sufficient skill, it is possible to make/modify leads for the task. proceed to Chapter 5. - "Cables, Making your own".

- Only the first two pins (+1 and -1) are connected to the indicated channel. However - for Channel A ONLY, pins +2 and -2 are tied to Channel B, to allow both output channels to be carried on one cable. (this pattern is also repeated for channel pair C and D and input C.)

NOTE: - Generously Heavy Duty Speaker Cable should be used to ensure optimal performance of the amplifier and loudspeaker system. The cable should be at least comparable to good heavy duty 13 amp mains flex.

The use of heavy cable where a low total impedance is presented to the amplifier channel. Unduly long cable runs should be avoided where possible.

Excessively thin cable prevents the amplifier from delivering its full potential to the speakers, wasting the energy as heat in the cable. Under extreme circumstances this may even cause the cable to start a fire.



CAUTION: - Great care should be taken to ensure cables are in good condition and connectors are wired correctly and safely as short circuits and intermittent connections may cause damage to equipment and in extreme circumstances a fire hazard may occur. Exposed connections/bare wire present an electrocution hazard. Never use incompletely housed Speakon connectors to make connections

Cable testers which allow you to hook up both ends of the cable and confirm correct wiring are available and purchasing one as a standard tool for debugging and partial safety assurance is recommended.



(7) Input Signal Sockets

Signal input connections are provided via Female XLR sockets.

Industry standard Balanced XLR format, which helps ensure interference and noise free connections between equipment.

Ready-made, sensibly priced, quality interconnection leads suitable for use with the amplifier should be easy to source. However, with sufficient skill, it is possible to make/modify leads for the task. Proceed to Chapter 5. - "Cables, Making your own".

(9) Power Connection

Powercon Mains Inlet:

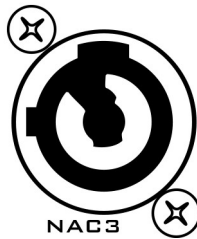

Mains power is supplied to the amplifier by a 20 Amp Powercon mains socket. An appropriate mains lead is supplied with the amplifier.

Note: *The amplifier requires a stable power supply to function as intended. Ensure that the power source (mains power supply, generator, etc.) is suitable for this application and adequate power is available. Poorly selected power sources result in sub-optimal performance, increased likelihood of tripping breakers, blowing fuses and in extreme situations damage to equipment may occur.*



Should the fuse in the mains lead blow for any reason, it must be replaced with a fuse of the correct rating. This should be 13 amps for the models listed in this manual. However, if there is any reason to believe that a malfunction caused the fuse to blow, stop using the equipment immediately and take the amplifier to an authorised service engineer for servicing.

4. Recommended Usage:

To ensure your speaker and amplifier system functions optimally, it is advised to read through everything covered in this manual.

Safety precautions and appropriate usage recommendations for specific connections and features are noted in the previous section.

4.1 Matching Speakers to the amplifier:

When matching loudspeakers appropriately to the available amplification, it is generally best to ensure that their power rating in watts rms (or aes) is more or less the same for the rated impedance. For instance if a Speaker is rated at 600w Rms/aes (not peak, etc) at 8 ohms then ideally it should be matched to an amplifier channel rated to supply 600w rms at 8 ohms for continuous music usage.

For certain specialist applications (cinema, theatre, public address, etc) it is occasionally specified that additional amplifier headroom should be allowed for. This usually means that an amplifier channel power rating twice that of the speakers is used (a 1200w amplifier channel connected to a 600w speaker system). The amplifiers are then usually driven to no more than -3db of their potential. This practice is not recommended to anyone unsure of the implications.

Some degree of tolerance in matching speaker wattage, to that of the amplifier is generally acceptable. Safe limits are dependent on many factors and there is no simple formula to determine the acceptable range. Determination of safe use is down to user discretion. If in doubt, consult a qualified technician for advice.

There are however some signs which suggest that the loudspeaker and amplifier system is being driven beyond acceptable limits. Firstly, where the speakers power rating is larger than that of the amplifier channel, the clip or peak lights will illuminate repeatedly on the amplifier if it is being driven too hard, this will often also result in an audible increase in distortion of the sound from the speaker system. Where this happens, the volume level should be reduced.

Where the amplifier channel can deliver significantly more power to the speaker system than it is rated for, even greater care should be taken, as it is not always be clear when the power handling of the speaker system has been exceeded. However certain artefacts will usually present themselves before the amplifier reaches full output. Exceeding the power handling of the speaker system will usually result in an audible rise in distortion and other artefacts. Exceeding a safe level for a prolonged period of time may result in permanent damage to the speakers and under extreme circumstances the amplifier also.

Extreme mismatches in amplifier and speaker power rating are not recommended. As the possible combinations can very easily result in damage to both amplifier and speaker system.

When connecting multiple speaker systems to the same amplifier channel, it should be noted that this halves the impedance load seen by the amplifier. All speakers connected should be of the same impedance rating. For instance if two 8 ohm rated cabinets are connected in parallel to the amplifier this would result in (8 ohms divided by 2 cabinets) 4 ohms.

Usually this will result in an approximate doubling of power delivered from the amplifier to the speakers. To determine the power level the speakers will be subjected to, consult the specifications in section 2 of this manual. Also note that because the power is dissipated across two speaker systems, that the power is shared between them. Therefore 600w from the amplifier at 4 ohms becomes 300w seen by each 8 ohm speaker connected in parallel on that amplifier output channel. Ensure that the speaker system remains appropriately matched as discussed previously.

Although some of the amplifier models are rated for 2 ohms usage it is not generally recommended that speaker loads less than 4 ohms are presented to any given amplifier channel. As performance can sometimes be degraded. Abuse from connecting inappropriate loads can damage both the amplifier and speaker systems. With amplifier models which offer a bridged mode of operation, note that minimum impedance normally doubles to 4 or 8 ohms depending on the model used. Also note the custom wiring required for connecting the speakers in bridged mode. Using Standard connections will result in exceptionally poor performance.

5. Cables, Making your own.

5.1 Signal Level Leads.

Standard Audio Connectors:

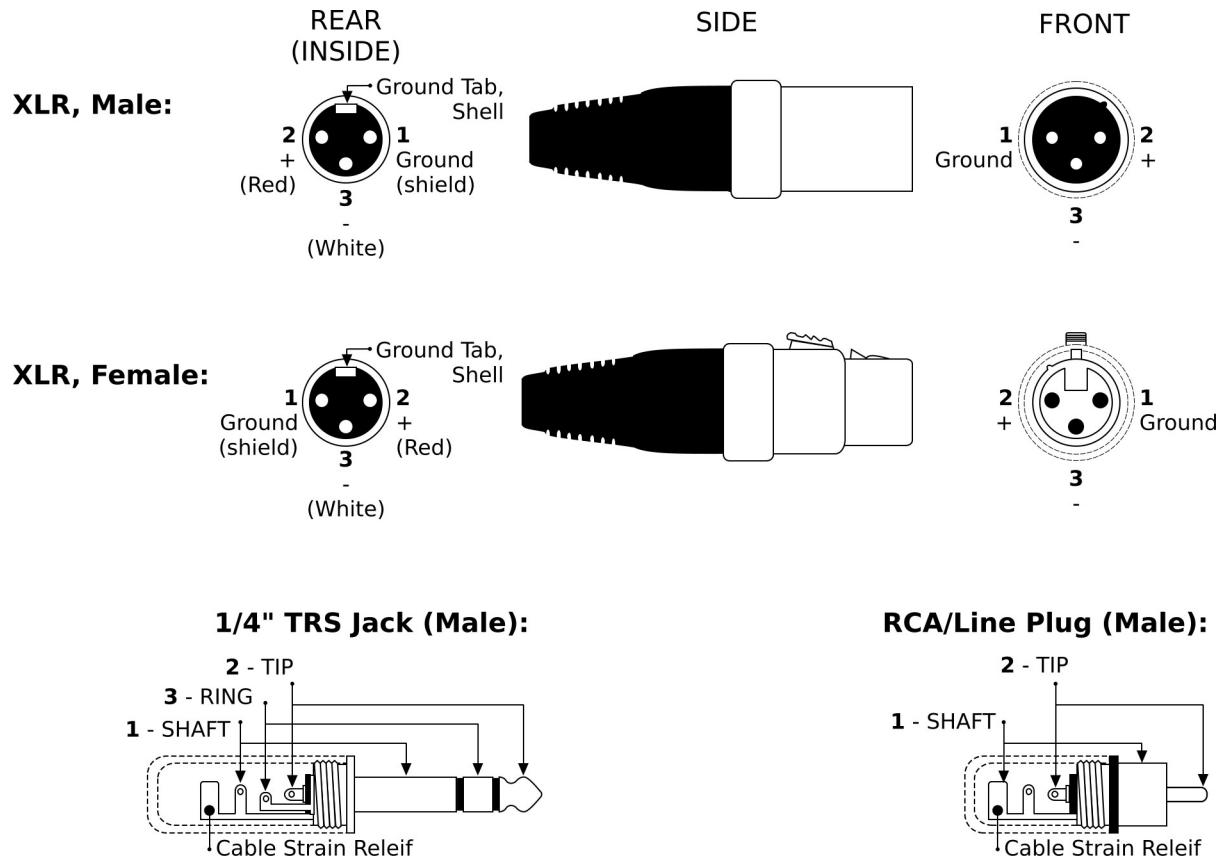

Cable Maker Table:

	Cable Connections:		
Cable Type:	Ground/Screen	Red/Central Cable	White
balanced to balanced	1 to 1	2 to 2	3 to 3
balanced to unbalanced	1 to 1	2 to 2	3 tied to 1
unbalanced to unbalanced	1 to 1	2 to 2	-

Note: Shell Ground tab on XLR connectors is usually tied to ground at pin 1.

Choosing a Cable:

For balanced connections, use a good quality metal braid screened cable with two inner wire cores; this will usually be clearly marketed as pro audio/microphone signal cable.

For long cable runs in excess of 6m/20ft, try to use cables with lower capacitance ratings, to minimise any loss of sound quality. Keep cable runs short where possible, however be sure allow a little bit of slack in the length of cable used to make the lead. Stretched, overstressed cables tend to break at the most inconvenient moments.

5.2 Speaker Leads.

Speakon Connectors, 4 Pin:

**4 Way SPEAKON Plug:
(INSIDE)**

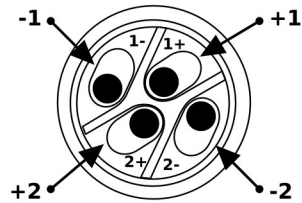

SIDE VIEW

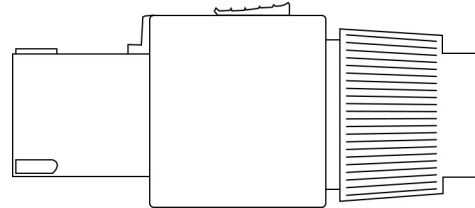

Cable Maker Table:

	Cable Connections:	
Cable Type:	+ and -	+ and -
Single Channel, 2 core lead.	1 to 1	-
Dual Channel, 4 core lead. For both channels into one cable. Outputs A,B,C and D - 4 ohms min. load	1 to 1	2 to 2
Bridged (mono) mode.	Not Applicable.	

Choosing a suitable Cable:

Cable Length:		Recommended Cable Gauge for Speaker Load:								
M:	FT:	4 Ohms			8 Ohms			16 Ohms		
		Power Loss % = .13 - .25 DF = 107 - 86 (67) DF - Damping Factor est.			Power Loss % = .13 - .62 DF = 215 - 105 (75) DF - Damping Factor est.			Power Loss % = .07 - .62 DF = 430 - 127 (86) DF - Damping Factor est.		
		wires	AWG	mm ²	wires	AWG	mm ²	wires	AWG	mm ²
1	3	2	12	2.5	2	12	2.5	2	12	2.5
	Rec Minimum:	2	16	1.3	2	16	1.3	2	16	1.3
3	10	4	12	2.5	2	12	2.5	2	12	2.5
	Rec Minimum:	2	12	2.5	2	16	1.3	2	16	1.3
6	20	4	10	5	4	12	2.5	2	12	2.5
	Rec Minimum:	4	12	2.5	2	12	2.5	2	14	2
10	33	-	-	-	4	10	5	2	10	5
	Rec Minimum:	4	10	5	2	10	5	2	12	2.5
15	49	-	-	-	4	10	5	2	10	5
	Rec Minimum:	-	-	-	2	12	2.5	2	12	2.5
24	79	-	-	-	-	-	-	4	10	5
	Rec Minimum:	-	-	-	4	10	5	2	10	5
30	98	-	-	-	-	-	-	4	10	5
	Rec Minimum:	-	-	-	-	-	-	4	12	2.5

The previous table is a rough guide for recommended cable gauges. It is important to use sufficiently heavy duty cables (try to use at least 2.5mm²) and plan the use and installation of sound equipment such that the speaker cables in particular are kept short where possible (under 6m/20ft should provide enough flexibility to cover most applications).

Speaker cables are usually made with copper to act as the conductor carrying power. Although it is well suited to this task, it is still not perfect and has an undesirable property in the form of resistance. This factor becomes a problem where cables are long and also of insufficient thickness.

Cables intended for speaker use are commonly found in sizes of 1.5, 2.5, 4mm² . Unfortunately, people still advertise their cables with a confusing mix of different standards. Cables are also measured in the diameter of the copper core (often confused with mm²), AWG and a few others. Rough conversion for AWG and Diameter to mm² are included in the tables on the previous page.

Poor cable selection results in power being lost in the speaker cable as heat, and also can dramatically reduce the amplifier's 'Damping Factor' – this is how tightly the speaker system is controlled by the amplifier. Greatly reduced damping results in reduced sound quality; Typically bass starts to lack the snappy bite on kick drums and toms, and a booming drone occurs through the driver failing to stop moving when the sound has passed.

Reducing the total resistance of the speaker load will demand heavier, shorter cables to be used in order to keep the losses and degradation to a minimum. Loads of less than 4 ohms are not generally recommended, even for amplifiers which will support them, as it puts the amplifier under considerable stress and also dramatically reduces the damping factor. Typically a 2 ohm load will compromise damping factor enough to audibly degrade the performance of the speaker system.

Consult the tables on the previous page, to determine a suitable cable gauge for your required cable length and speaker impedance.

Notes:

- *The tables quote the gauge/area of the copper for each individual wire; the 'Wire' column assumes in stating '2' wires – that one wire to each terminal of the speaker (+/-) is used. '4' wires assumes that a with a 4 core cable, that the wires are paired to make 2 connections to one pair of terminals.*
- *Take extra care in ensuring that the + and - connections do not get reversed in the leads. Whilst this will not usually cause damage, it will result in poor performance. When a cable feeding one speaker cabinet is wired backwards, it will result in partial cancellation of sound between the two speakers. Usually this presents itself as reduced bass levels and indistinct stereo image.*
- *Purchase of a cable tester specifically for audio leads is recommended; as this makes it easy to identify and detect problems in wiring which may otherwise slip by unnoticed.*
- ***NEVER use light duty cable which has not been designed for high power audio use ('bell' wire, cat 5 cables, etc); this will result in poor performance and can present a fire hazard.***
- ***NEVER Pair together (-) negative/'ground' cables from different amplifiers, this will result in amplifier malfunction and can easily result in permanent damage to speaker systems, amplifiers and associated equipment.***



6. TROUBLE SHOOTING.

(1) ALWAYS:

- **Ensure the amplifier has no less than 4 Ohms worth of loading across each channel.**
- **Ensure wiring is safe and correct.**

(2) NORMAL ARTIFACTS:

- When heavily driven, the amplifier itself may make a noticeable hissing sound in relation to the supplied signal. This is a normal phenomenon relating to the behaviour of certain components which vibrate slightly under the high powers involved.
- The Fans on the XT Series may appear to generate more noise than earlier models, they run at higher speeds to increase the cooling efficiency of the amplifiers. They will also increase their speed when the amplifier is under load.

(3) THE POWER LIGHTS DO NOT ILLUMINATE

1. Check that the mains supply is turned on.
2. Check that the mains switch is turned on.
3. Check Mains lead for damage & check fuse. Replace lead if damaged, replace fuse if blown.
4. Check internal fuse. Replace if blown.
(same type of fuse specified/installed must be used, do not change)
5. If fuse re-blows refer to service personnel.
6. If fuse has not blown, but the amplifier still malfunctions, refer to service personnel.

(4) THE AMPLIFIER IS WORKING, BUT OUTPUT VOLUME IS LOW

- Check the signal from the input source and signal cables. The amplifiers are designed to operate at an input voltage of 1.2V. If the signal source is below this refer to qualified service personnel for a minor modification.

(5) AMP OUTPUT LEVEL INDICATORS ARE WORKING, BUT NO SOUND IS COMING OUT

- Check Speakon connectors are securely attached.
(The amplifier must be operating if the output level indicators are working)

(6) THE AMPLIFIER IS GIVING A LOWER OUTPUT THAN NORMAL, WITH DISTORTION

- The protection circuits (current clamps) are operating. Check all leads for short-circuits. Try another set of leads and loudspeakers.

(7) THE AMPLIFIER IS OVERHEATING

- Check that the fan is not obstructed with debris, and is rotating freely.
- Check speaker leads for short circuits.
- Check to see that amplifier output 'negatives' have -not- been connected together in bundled cable looms.

If any of these, or other symptoms persist, Please contact us with the details below for help, advice and service:

Contact Details:

Email: support@matrix-amplification.com

Address:

MATRIX AMPLIFICATION LIMITED,
Matrix Amplification,
Little Castle Farm,
Pen-Y-Park Road,
Usk,
United Kingdom,
NP15 2BX.

If the amplifier is to be shipped, use factory packaging or other secure method as transit damage is not covered by the warranty.

Full Two Year Warranty

Summary of Warranty

Matrix Amplification Limited, warrant to you, the ORIGINAL PURCHASER of each Matrix Power Amplifier, for a period of 2 (two) years from the date of purchase, that the amplifier is free from defects in materials and workmanship and we further warrant the new Matrix Amplifier, regardless of the reason of failure except as excluded in this warranty.

Items Subject to Exclusion from this Warranty

This Matrix Amplifier Warranty is in effect only for failure of a new Matrix Amplifier which occurred during the warranty period. It does not cover any product that has been damaged because of any misuse be it intentional or otherwise, accident, negligence, or loss which is covered under any insurance.

What the Warranter Will Do

We will remedy any defect, regardless of the reason for failure (except as excluded above), by repair or replacement. Warranty work can only be performed at our authorised distributors or at Matrix Amplification Limited. We will remedy the defect and ship the product from the service centre or our own factory within a reasonable time after receipt of the defective product. All expenses in remedying the defect, including freight costs from ourselves to you (within mainland UK) will be borne by us. You must bear the costs of shipping the product to our authorised service centre or factory.

How to Obtain Warranty Service

You must notify us of your need for warranty service not later than the expiry of your warranty. The amplifier must be shipped in a factory pack, which if required can be obtained from us at a modest charge. The amplifier must be sent to us carriage paid and insured.

Corrective action will be taken within a reasonable time from the date of receipt of the defective product by us or our authorised service center. If repairs made by us or our authorised service center are not satisfactory, contact us immediately.

Warranty Alterations

No person has the authority to enlarge, amend or modify this warranty. The warranty is not extended by the length of time which you are deprived of the use of the amplifier. Repairs and replacement parts will only carry the unexpired portion of this warranty.

Design Changes

Matrix Amplification Limited has a policy of continuous improvement to designs without notice and with no obligation to make corresponding changes in products previously manufactured.

Your Statutory Rights are Unaffected by this Warranty

Declaration of CE Conformity

Issuers Name and Address: Andrew Hunt,
MATRIX AMPLIFICATION LIMITED,
Cordes House, Factory Road, Newport, Gwent, United Kingdom.
NP20 5FA

Products: XT2004 / X4004 / XT6004

Equipment Type: Commercial Audio Power Amplifiers.

Safety Standard:

AMD1: 2005 and IEC 60065: 2001 7th Ed. Safety Requirements - Audio Video and Similar Electronic Apparatus.

EMC Standards:

EN 61000-4-2:2001 Electrostatic Discharge Immunity (Environment E2-Criteria B, 4k V Contact, 8k V Air Discharge).

EN 61000-4-3:2006 Radiated, Radio-Frequency, Electromagnetic Immunity (Environment E2, criteria A).

EN 61000-4-4:2007 Electrical Fast Transient/Burst Immunity (Criteria B).

EN 61000-4-5:2006 Surge Immunity (Criteria B).

EN 61000-4-6:2006 Immunity to Conducted Disturbances Induced by Radio-Frequency Fields (Criteria A).

EN 61000-4-11:2001 Voltage Dips, Short Interruptions and Voltage Variation.

EN 55103-1:1997 Electromagnetic Compatibility - Product Family Standard for Audio, Video, Audio-Visual and Entertainment Lighting Control Apparatus for Professional Use, Part 1: Emissions.

EN 55103-1:1997 Magnetic Field Emissions-Annex A @ 10 cm and 20 cm.

EN 55103-2:1997 Electromagnetic Compatibility - Product Family Standard for Audio, Video, Audio-Visual and Entertainment Lighting Control Apparatus for Professional Use, Part 2: Immunity.

EN 61000-3-2:2005 and AMD1: 2008 Limits for Harmonic Current Emissions (equipment input current less than or equal to 16 A per phase).

EN 55022:2006 Limits and Methods of Measurement of Radio Disturbance Characteristics of ITE: Radiated, Class B Limits; Conducted, Class A.

EN 61000-3-3:2008 Limitation of Voltage Fluctuations and Flicker in Low-Voltage Supply Systems Rated Current less than or equal to 16A.

Declaration:

I certify that the product identified above conforms to the requirements of the EMC Council Directive 89/336/EEC as amended by 92/31/EEC, and the Low Voltage Directive 73/23/EES as amended by 93/68/EEC.

Signatories:
Andrew Hunt,
Managing Director.



Date of Issue:
12 June 2010.